

electriQ

**Premium Low Energy Dehumidifier &
Air Purifier with UV and Plasma Ionizer
Smart WIFI App and Remote Controlled**

CD12PRO-LE – 12 litres per day

CD20PRO-LE – 20 litres per day

USER MANUAL



Thank you for choosing ElectriQ

**Please read this user manual before using this innovative Dehumidifier
and keep it safe for future reference**

Visit our page www.electriQ.co.uk for our entire range of Intelligent Electricals

CONTENTS

Safety Instructions	2
Installation	4
Parts	5
Control Panel	6
Quick reference guide	9
Remote Control Features	12
How to Connect to WiFi	14
Positioning	15
Water Drainage	15
Care and Maintenance	17
Frequently Asked Questions	18
Troubleshooting	19
Technical Data	20

SAFETY INSTRUCTIONS

Important

- Carefully read the instructions before operating the unit
- This appliance is only intended for use in an indoor domestic environment. Any other use is not recommended by the manufacturer and may cause fire, electrical shocks or other injury to user or property.
- Rating: This unit must be connected to a 220-240 V / 50 Hz earthed outlet.
- Installation must be in accordance with regulations of the country where the unit is used.
- If you are in any doubt about the suitability of your electrical supply, have it checked and if necessary modified by a qualified electrician.
- This dehumidifier has been tested and is safe to use. However, as with any electrical appliance - use it with care.
- Disconnect the power plug from the socket before dismantling, assembling or cleaning.
- Avoid touching any moving parts within the appliance.
- Never insert fingers, pencils or any other objects through the guard.
- This appliance is not intended for use by persons (including children) with reduced physical, sensory or mental capabilities. It is also not intended for use by those with a lack of experience and knowledge, unless they have been given supervision or instruction concerning the use of the appliance by a person responsible for their safety.
- Do not leave children unsupervised with this appliance.
- Do not clean the unit by spraying it or immersing it in water.
- Never connect the unit to an electrical outlet using an extension cord. If a power outlet is not available, one should be installed by a qualified electrician.
- Never operate this appliance if the cord, power adapter or plug is damaged. Ensure the power cord is not stretched or exposed to sharp object/edges.
- A damaged power supply cord should be replaced by the manufacturer or a qualified electrician in order to avoid a hazard.
- Any service other than regular cleaning or filter replacement should be performed by an authorized service representative. Failure to comply could result in a voided warranty.
- Do not use the appliance for any other purposes than its intended use.
- Do not tilt the unit while in use. The unit is designed to work only in a vertical position.
- This dehumidifier must always be stored and transported upright, otherwise irreparable damage may be caused to the compressor; if in doubt we suggest waiting at least 24 hours before starting the unit.
- Avoid restarting the dehumidifier unit unless 5 minutes have passed since being turned off. This prevents damage to the compressor.
- Never use the mains plug or an external timer as a switch to start and turn off the dehumidifier. Only use the provided ON/OFF button located on the control panel.
- Always place the unit on a dry and stable surface.
- The appliance should not be installed in a laundry or wet room where the humidity is higher than 85% RH.
- Do not dry laundry directly above the unit. To prevent water entering the dehumidifier, laundry should be placed at least 1 meter away from your dehumidifier.

- Do not place the unit next to heat sources (e.g. electrical fires, fireplaces, etc.)
- Avoid mishandling the dehumidifier. Dropping or throwing the unit can cause damage to its internals and increases the risks of operating it.
- Do not store or use gasoline, petrol, paint, solvents or other flammable vapours or liquids in the vicinity of this dehumidifier or any other appliance.
- This dehumidifier must not be used in spaces where there is a high concentration of gases, solvent or other volatile organic compounds; in very dusty environments; in any domestic, commercial or industrial environment where air composition is flammable.

Energy Saving and Unit Safety Protection Tips

- Do not cover or restrict the airflow from the outlet or inlet grilles. Do not operate and follow the troubleshooting procedure if the self-opening louvers do not open on power on.
- For maximum performance the minimum distance from a wall or objects should be 20 cm.
- Keep the filters and grilles of the unit clean. Under normal conditions, the filters and grilles should only need cleaning once every three weeks (approximately).
- Since the filters remove airborne particles, more frequent cleaning may be necessary depending on the air quality. Vacuum both mesh and optional carbon filters and wash the mesh filters with hot soapy water and dry them before placing them back in the unit.

Quick visual safety guide on where or when not to use your dehumidifier

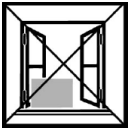

Exposed to the weather outdoors



Near water



If the power cable wires are frayed or cut



Where small children may be left unattended



If an extension lead may become overloaded



Where the power cable may be damaged

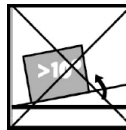

On a slope or uneven surface



Where there is risk of fire or close to a naked flame



Where it may be damaged by chemicals

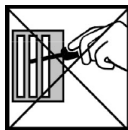

Where there is a risk or interference by foreign objects



This product is not made for DIY repair



If there is a risk of water falling on the unit

Installation

Remove any water from the water tank before starting the unit. In order to save energy, do not open windows or doors while the unit is running. Place the unit on a hard / flat surface. On first use run the unit continuously for 24 hrs.

To reduce noise levels:

Place a piece of carpet or a rubber mat under the unit to reduce any vibrations while the unit is running.

CD12PRO-LE & CD20PRO-LE dehumidifiers use compressor technology to extract water from the environment. Compressor dehumidifiers are ideal for normal domestic or office environments which are heated during the winter months and maintain temperatures above 12-15°C.

They are easy to move around on castors. With their intelligent logic they are designed to remove unwanted humidity while minimising operating costs. The CD12PRO-LE & CD20PRO-LE both feature an intelligent humidistat which is adjustable in increments of 5% from 35-80% RH giving you the ability to ensure your room is not dried too much and power is not wasted.

Features :

Your dehumidifier belongs to the electriQ low energy premium dehumidifiers featuring low power consumption, power saving logic and advanced air purification option.

1. Easy to use controls
2. Low energy only uses a fraction of the electricity of similar dehumidifiers
3. Great for up to 3 bed (CD12PRO-LE) and 5 bed (CD20PRO-LE) houses
4. Cost effective way to combat mould, condensation and damp
5. Dries laundry more efficiently than a tumble dryer
6. Designed to complement any modern space
7. High and low fan speed selection for best balance between running quiet and maximum water extraction
8. Anti-dust self-closing oscillating louvres for improved air flow
9. Castors for improved mobility
10. Intelligent CPU controlled digital humidistat with 35-80% RH and room humidity display
11. 24 hours start / stop timer
12. Tank operation or permanent drainage option with splash proof tank
13. Tank full alarm & auto-stop function
14. Air purifier function with plasma Ionizer and UV sterilisation
15. Remote control with integrated humidistat and follow me function which adjusts the operation of the unit according to where the remote is situated, the remote acts just like a humidity/ temperature sensor.
16. App control, allowing the unit to be remote scheduled and settings to be changed from Android and Apple Phones – great for caravans, holiday homes, museums, children rooms, offices etc.

PARTS

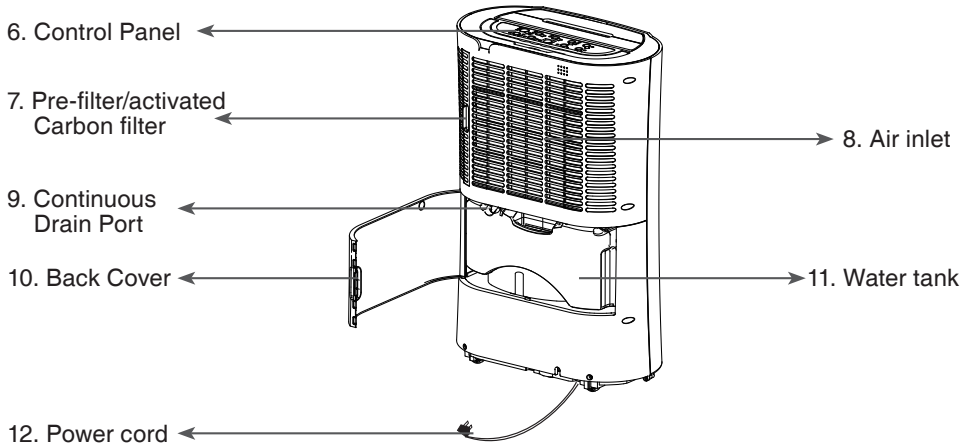
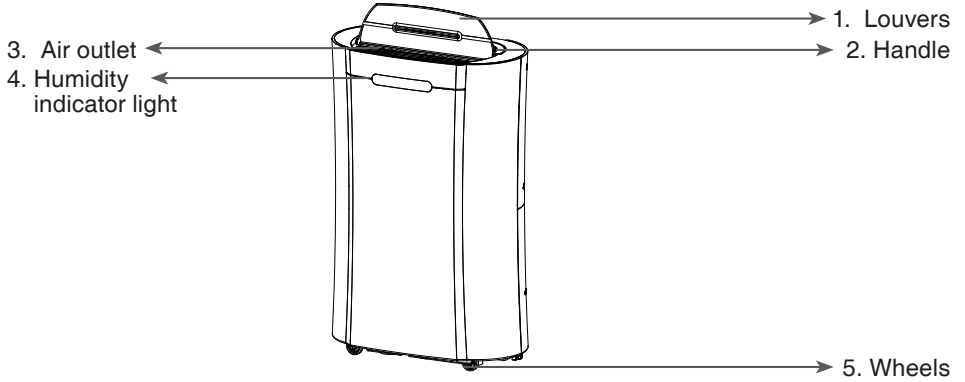

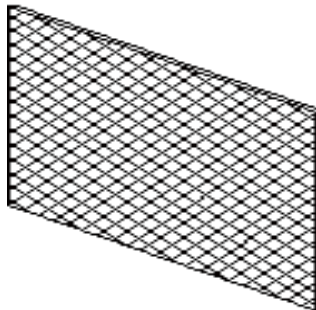

• *OPTIONAL*





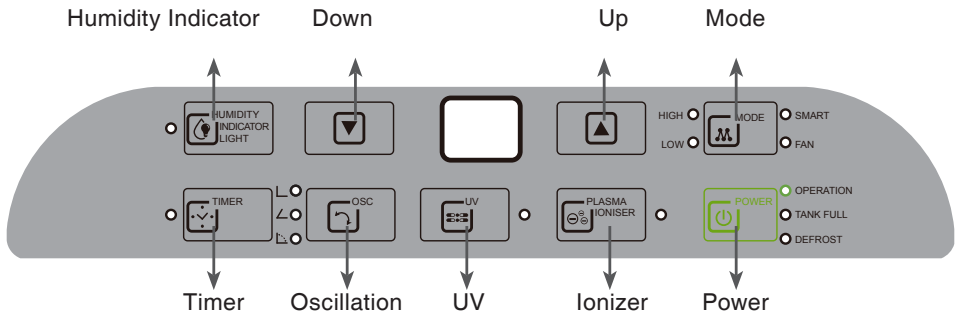

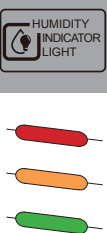

Activated carbon filter (Optional)

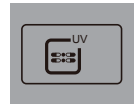
CONTROL PANEL



	<p>POWER Button Turns the appliance on and off.</p>
	<p>MODE Button Select the mode of the unit between: SMART / HIGH / LOW / and FAN. The unit will default to SMART mode the first time it is switched on and remains in this mode until another option is chosen. SMART Mode – Desired humidity set to 50 – 55% relative humidity and the fan is automatically adjusted depending on current humidity level. The desired humidity cannot be changed in this mode. HIGH/LOW Mode – Select the Fan speed, the desired humidity can then be adjusted using the Up and Down Buttons. FAN Mode – No moisture will be extracted in this mode, which when used with filters will purify the air. The UV and Plasma ionizer can also be used in this mode to further improve the quality of air emitted.</p>
	<p>HUMIDITY INDICATOR Button When the appliance is started, the indicator light will turn on automatically. The indicator light colour will change according to the humidity condition Red – High humidity, Relative Humidity $\geq 70\%$ Orange – Comfortable level, $70\% > \text{Relative Humidity} \geq 60\%$ Green – Air is dry, Relative Humidity $< 60\%$ The "Humidity Indicator light" button can be pressed to turn on/off the indicator light. Note: It can take around 2 minutes after the humidity has changed into a different colour bracket for the indicator will change the colour e.g. if humidity drops to 55% may take 2 minutes before the indicator changes to green</p>

	<p>OSC. Button(oscillating function) There are three different options, 45, 90 degree and swing, the louvers will move in swing mode or be fixed in selected position. Use 45 degree or swing for Laundry mode</p>
	<p>UV Light Button (For air purification) To select "UV", press the "UV" button and the indicator light to the right of the button will illuminate. The germicidal UV light improves the air quality by destroying germs, bacteria, fungi.</p>
	<p>PLASMA IONISER Button (ionization function) To activate the ionizer press the Plasma Ioniser button. The LED to the right of the button will illuminate to show the mode is active. The ionizer can refresh the air while killing viruses, dust mites, mould and airborne allergens.</p>
	<p>HUMIDITY SETTING Buttons Press UP / DOWN buttons to select the desired relative humidity level. The default relative humidity is 55%. When a relative humidity of 35% is selected, the compressor will not stop until water tank full. Please note these buttons will not adjust the desired humidity in smart mode.</p>
	<p>TIMER Button When the button is pressed, the led to the left of the button will illuminate to show the mode has been activated. The timer can be turned off again by pressing the timer button. The indicator LED will then turn off. The Timer can be used in 2 different ways Delayed power-on: With the unit in standby, activate the timer mode and use the "UP" and "DOWN" buttons to select in how many hours time you require the unit to start Delayed power-off: With the unit turned on, activate the timer mode and use the "UP" and "DOWN" buttons to select in how many hours time you require the unit to turn off.</p>
	<p>INTELLIGENT DEFROST The appliance will defrost automatically as programmed once the coil sensor detects the temperature is too low, to prevent ice from building within the unit. The defrost indicator will light up to show this mode is active. Once the defrosting process has finished, the appliance will recover to its previous running mode.</p>
	<p>TANK-FULL If the water tank is full, the indicator light will flash, please empty the water tank to continue operation. The light will also illuminate if the tank is incorrectly fitted.</p>
	<p>OPERATION The Operation light will illuminate when the compressor within the unit is running to extract moisture from the air. Please note this may not light up immediately when the unit is started, and will go out when the desired humidity is reached.</p>

Humidity Level & Timer 2 digit display

The led indicator performs the following functions:

When the unit is plugged in - It will indicate the room humidity level

When one of the humidity setting button is pressed - it will indicate the set humidity, before reverting to showing the current humidity after a few seconds

When the timer button is pressed it will indicate in how many hours the timer function will operate, before reverting to showing the current humidity after a few seconds



Notes: When the humidity level is outside the normal operational parameters the display will show LO or HI. If ambient humidity is lower than 20%, it will show “LO” If ambient humidity is higher than 90%, it will show “HI”. The dehumidifying function will be deactivated until the humidity has re entered the normal range to prevent damage to the unit.

Optional carbon filter (air purification function)

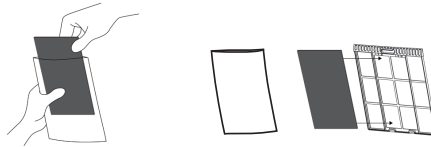

Take out the carbon filter from bag and insert it on the filter. It is suggested to Hoover the carbon filter every 2-3 weeks and change them every 3-6 months to always keep the room fresh and odor free.





QUICK REFERENCE GUIDE

Power Button  Press the power button to turn the dehumidifier on and off.

Swing control Button  Press once to make the louvre swing and press again to lock at 45 degrees, press again to lock at 90 degrees. Do not operate the unit if the self-opening louvers do not open when the unit is powered on.

Timer Button: Press the timer button  then use   buttons to adjust the timer (1-24 hrs, start/ stopping timer). In power on mode the set number will represent the number of hours the unit will run for before turning off. This will remain unaffected if unit goes in to defrost mode or the tank is emptied than reinserted. In standby mode the set number represents the period in hours after which the unit will start. To cancel the timer press the timer button again.

Humidity Buttons: Press the **Up**  or **Down**  buttons when the unit is displaying the current relative humidity to select the desired humidity level. The humidity level can be set between a range of 35% RH (Relative Humidity) to 80% RH in 5% increments. Please note the desired humidity cannot be changed when the unit is in SMART mode.

SMART Mode: This is designed for maximum convenience as it maintains the room at an ideal domestic environment humidity level of 50-55% RH while saving electricity. This is the default mode and is recommended for most users.

The compressor will work until the desired humidity is reached and then will stop;



Low Fan Mode: The fan will move the air around the room ensuring the entire air in the room is processed and the relative humidity correctly measured. This mode gives you the ability to adjust the desired humidity, while running the fan at a lower speed.

High Fan Mode: The fan will move the air around the room ensuring the entire air in the room is processed and the relative humidity correctly measured. This mode gives you the ability to adjust the desired humidity, while running the fan at the high speed. Allowing more air to pass over the coils than in low fan speed.

Laundry Mode: for the dehumidifier to operate continuously with maximum water extraction until the tank is full, set the unit to High Fan mode and set the desired humidity level to 35%-50% RH. 35% is very dry and

the unit will work until water tank is full as 35%RH is hardly achievable in UK domestic environment. The louvres should be set to either swing mode or to 45 degrees directing the airflow onto clothes / laundry. Do not place clothes directly over the dehumidifier vents. Make sure that there is no obstruction to either the hot air exhaust air flow, or the air inlet. For best results place the laundry within 1.5 meters of the dehumidifier.

Please Note: If a permanent drainage pipe is fitted, the unit will not stop operation. Setting the desired humidity to around 35% is good for a drying boost, on the units initial run, or in emergencies. It is not recommended to use it with these settings for normal operation in domestic/ office environment over a long period of time, as the air may become uncomfortably dry.

For allowing more moisture in the air, press the humidity button to set to a higher percentage value (e.g. 60-70%).

Humidity set to 50-55% RH - Recommended setting, great for domestic operation and dry storage.

Humidity set to 60% RH - Great for personal comfort and applications where 50% RH is considered too dry.

Humidity set to 70% RH - Ideal for unoccupied properties or where an economical run is needed without the need to go drier than 70% RH

Other features and Indicators

Tank Full Light

The red light will illuminate and the unit will beep when the tank is ready to be emptied, or if the water tank is incorrectly inserted. The water level control will shut off the dehumidifier until the empty tank is replaced in its proper position

Auto Defrost

The appliance will defrost automatically as programmed once the coil sensor detects temperature is too low in order to prevent ice building inside the unit. When frost builds up on the evaporator coils, the compressor will cycle off and the unit will go in to defrost mode. The defrost indicator led will turn on to show defrost mode is active. Normal operation will resume after the defrost mode has completed.

Humidistat control and fan/ compressor operation

When the selected humidity is 2% lower than the user selected humidistat setting; the dehumidifier's compressor will be shut off automatically but the fan will still move to ensure air is not stale in the room. The unit will use only a minimal amount of energy in fan mode. When the humidity is equal or higher than user selected humidity the compressor will restart once the 3 minutes delay compressor protection expires.

Auto-Restart (on some models)

If the unit stops unexpectedly due to the power cut, it will restart with the previous function selected automatically when the power resumes.

Power

After the unit has stopped, it is not recommended to resume operation for at least 10 minutes. This is to protect the compressor. Operation can resume after this period lapses. When the unit is restarted there is a 3 minutes delay before compressor will start, to help prolong the life of your purchase

Lightweight Portable Design on castors

The dehumidifier is built to be compact and lightweight. The castors on the bottom of the unit make it easy to move from room to room.

Your dehumidifier is an advanced micro-CPU controlled device capable of self-diagnostics. The LCD display may also show the error and protections codes.

REMOTE CONTROL FEATURES

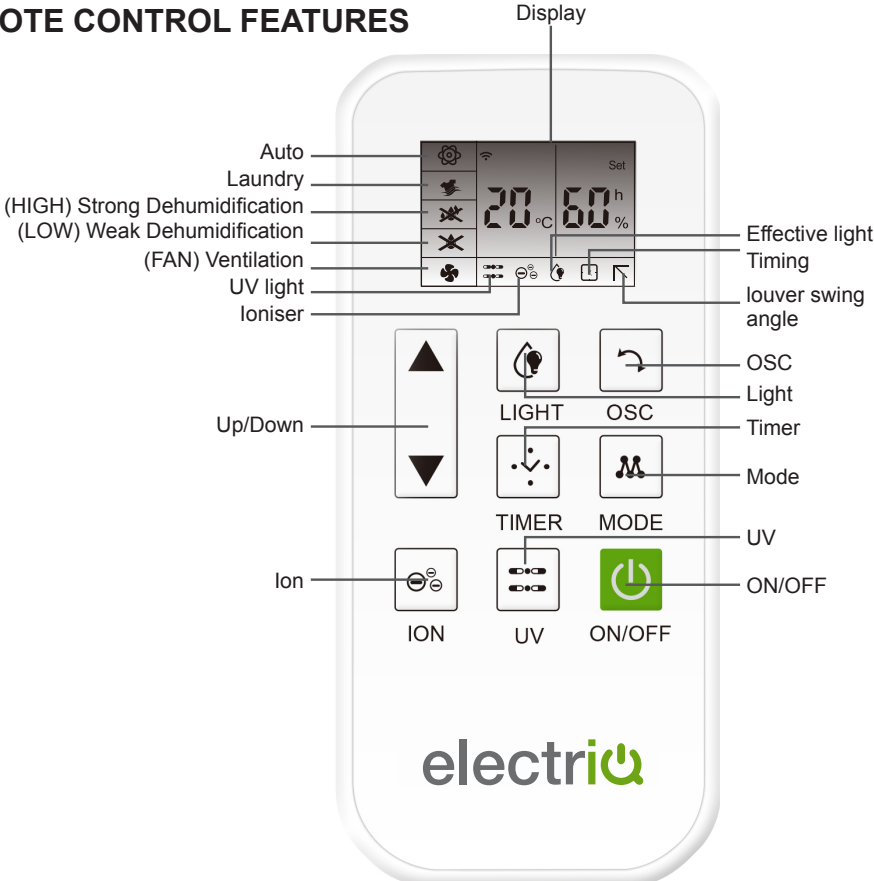

As well as containing an independent humidistat, allowing the humidity of the room to be measured away from the dehumidifier, the remote control contains many of the same buttons as found on the main unit, as well as a few other features.

Buttons on the Remote:

ON/OFF Button – Turns the dehumidifier on and off.

Mode Button - Select the functions of the unit between: SMART / LAUNDRY / HIGH / LOW / and FAN. The mode selected will be displayed on the left hand side of the screen on the remote. The laundry function is only available through the remote, and sets the desired humidity to 35%, to ensure the maximum amount of moisture is removed from the air.

OSC Button – Allows you to choose the position of the louvres between 45, 90 degree and swing. Repeatedly press the button to go through the options. The option chosen will be shown on the bottom right of the screen on the remote.

UV Button – Turns on the germicidal UV light to destroy germs, bacteria and fungi in the air. The UV icon will show at the bottom of the remote's screen when activated.

Timer Button – Press this, and then use the remote's up and down buttons to select the duration of the timer. When the unit is switched on, the unit will turn off when the timer has elapsed, and if it is switched off, the unit will turn on when the timer has elapsed. The timer can be deactivated by pressing the timer button again.

Light Button - Turns on the Humidity indicator mode, so that the LED on the front of the dehumidifier indicates the relative humidity of the room

Red – High humidity, Relative Humidity $\geq 70\%$

Orange – Comfortable level, $70\% > \text{Relative Humidity} \geq 60\%$

Green – Air is dry, Relative Humidity $< 60\%$

ION Button – Turns on the Plasma Ioniser. The ionizer can refresh the air while killing viruses, dust mites, mould and airborne allergens. The ioniser Icon will be displayed on the remote when this feature is operational

UP and DOWN Buttons - These are used to select the desired humidity within the room. When pressed the display will show the currently set humidity and the up and down buttons can be used to change the desired humidity. While the humidity settings are displayed on the remote (rather than the current relative humidity) the Set icon will be displayed on the remote. The  icon will turn off when the remote reverts to showing the relative humidity of the room.

Other Features on the remote:

“FOLLOW ME” Mode – The dehumidifier will work from the humidity reading taken by the remote, rather than from the dehumidifier itself. To do this, the remote sends a humidity reading to the dehumidifier each hour, which is then compared against the current setting, to decide whether the dehumidifier should be operating. To activate this mode press the up and down arrows on the remote at the same time, the  icon will flash to show the mode is running

Please note: When **FOLLOW ME** is on, the head of remote control should be pointed towards the dehumidifier and should be usually no more than 3 meters away from it. (e.g. you have a damp spot in the house and you want to monitor the humidity in that spot or next to a child bed instead). The follow me mode will fail if the remote is not positioned correctly towards the dehumidifier. Before activating follow me mode please ensure that you can operate the unit via remote control from where the remote is placed. Low battery will also affect the follow me mode.

Turn on / off the LED light on the dehumidifier - When the dehumidifier is running, press the ION button on the remote 4 times within 5 seconds, the dehumidifier will beep 2 times and the LED lights on dehumidifier will be turned off. The same can be done to turn the lights back on. This does not affect the operation of the dehumidifier.

Room temperature / humidity display– Your smart remote includes an inbuilt humidistat, allowing the humidity of the area to be measured from the remote. The humidity reading shown on the remote is the one measured by the remote, rather than transmitted from the dehumidifier.

Please note: This sensor works on natural airflow, and as such it will take more time than the dehumidifier to reach an accurate reading. Due to this and the different positioning of the remote the reading on the remote may differ from the figure shown on the dehumidifier.

How to connect the dehumidifier to WIFI

Ensure that your dehumidifier is in an area which receives good reception from your home WiFi Router. Turn on the power to the dehumidifier, so that the dehumidifier is working than

press and hold the mode  button on the dehumidifier, and release it after the dehumidifier has beeped 3 times. The unit is now ready to connect to your Wifi network. Please follow the smart App manual for further details on setting up and using the Smart App.

POSITIONING THE DEHUMIDIFIER

A badly positioned dehumidifier will have little effect. In positioning the dehumidifier please ensure circulation of air is not restricted around the unit. At least 20 cm space should be allowed around the unit.

This dehumidifier is designed for indoor residential / small office applications only and any commercial or industrial use will invalidate the warranty.

Use the dehumidifier in an enclosed area for maximum efficiency. Close all external doors and windows to create an effective operating environment. Do not use outdoors.

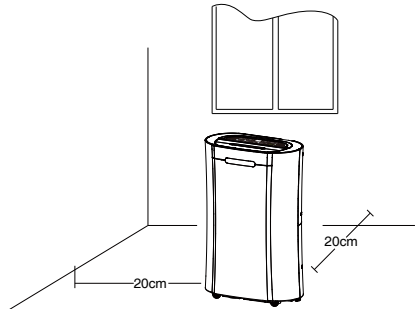

Your electriQ dehumidifier will begin to protect your space from the harmful effects of excessive moisture as soon as it is turned on. Excess moisture is dispersed throughout your home. For this reason, the dehumidifier should be positioned in a central and clear location so that it can draw this moist air towards it from all over the home. A warm hallway or landing is an ideal position for your dehumidifier. If possible, leave interior doors ajar to allow air circulation between rooms.

Alternatively, if you have a serious problem in one area you can begin by positioning the dehumidifier in that area and moving it to a more central location at a later date. Please note the unit should not be placed directly against a radiator or other heat source. When positioning your electriQ dehumidifier, ensure that it is placed clear of any obstacle that may limit the air movement, and it should be placed on a dry flat surface.

Please Note: Do not force castors to move over carpet or uneven surfaces, nor move the unit with water in the tank as it may tip over and spill.

WATER DRAINAGE

When the water tank is full, the unit will stop automatically. When this happens the **tank full** red light will show on the control panel.

Note: Only empty the water tank when it is full or before moving or storing the unit. There are two ways to dispense collected water.

Use the internal water tank.

When the tank is full, the unit will automatically stop running, and the Full indicator light will flash. Grip the tank by its handle securely, and carefully pull out. Empty the water tank and reinsert it into the dehumidifier. The tank must be in place and securely seated for the dehumidifier to operate again. The dehumidifier will re-start when the tank is restored to its correct position.

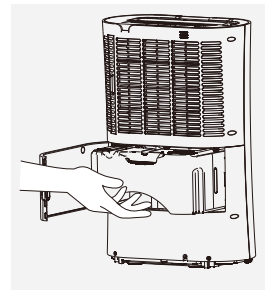

NOTES:

- Do not remove the water tank immediately after the unit stops. Please wait a while to avoid the water dripping into the unit and causing damage.
- Only empty the water tank when it is full or before moving or storing the unit.
- Do not rest the tank on the floor because the bottom of the tank could be uneven and tank may fall and cause the water to spill.
- When you remove the tank, do not touch sensors or any parts which are situated behind tank. Doing so may damage the product. Be sure to push the tank gently all the way into the unit. Banging the bucket against anything or failing to push it in securely into place may cause the unit not to operate.
- Do not remove or damage the float switch in the water-tank, otherwise the machine will stop working.
- Please make sure the water tank cover is put back into place correctly before the water tank is reinserted.
- If the water-tank is inserted incorrectly, the tank full indicator will flash. Remove the water tank and reinsert to turn the indicator off and resume normal use.
- At all times, avoid water entering the unit. It may cause an electrical hazard and damage the unit.

Set up continuous drainage

This dehumidifier has a continuous drain hole that can be connected to a plastic pipe with an 10 mm inner diameter (Not Supplied). Water can be automatically plumbed in or drained into a sink, a larger receptacle or through the wall into an outside drain. Please follow the steps below to set your unit up for continuous drainage.

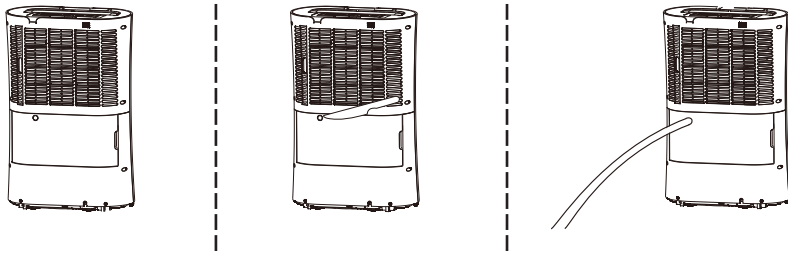

1. Cut off the cover for the continuous drain on the back of the unit.
2. Pull out the water tank and connect a water tube of inner diameter 10mm to the drain connector, and ensure the connection is tight * Please note, **the water tube is not supplied with the unit.**
3. Return the water tank back into position within the unit

This unit uses gravity fall to dispose water hence the drain should be lower than the dehumidifier water outlet. Be sure to run the water pipe downward and let the water flow out smoothly. Do not kink or bend the pipe.

NOTE: When the continuous drain feature is not being used, reverse the pipe installation, to start the water collecting in the water tank.

The permanent drain can be used in conjunction with water pump (e.g. when draining from a cellar) to lift the water upwards.

CARE AND MAINTENANCE

Always shut off the unit and unplug it from the mains before cleaning or performing any maintenance. When it is not in use for long periods, it is advisable to remove the plug from the power socket. Do not use chemical solvents (such as benzene, alcohol or gasoline) as they may cause irreversible damage to the unit.

Filter Cleaning

The Air-inlet may gather dust easily, please clean it often with a soft, damp cloth. If the filter is covered by dust, the airflow and the performance of the unit will be affected, it may even cause damage to the unit. We recommend that you regularly clean the filters. The dehumidifier must be disconnected from the socket before maintenance and the filters must be allowed to fully dry before re use.

1. Remove the filters from the unit, and tap the dust away.
2. Clean the carbon (Optional) and the mesh filter with a vacuum cleaner or soft-brush
3. If dirt and grease is accumulated wash the mesh filter in hot soapy water
4. Replace the filters in position as shown in the diagram.

Note: Never use the unit without the antibacterial mesh dust filter. The active carbon filter is optional and should be replaced if necessary after 1-1 ½ years of usage.

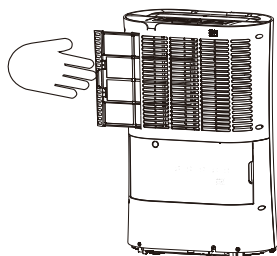

Clean the Grille and Case

Use water and a mild detergent to clean the washable mesh filters. Do not use bleach or abrasives. Do not splash water directly onto the main unit. Doing so may cause an electrical shock and can lead to the insulation to deteriorate, or cause the unit to rust. The air intake and outlet grilles get soiled easily, so use a vacuum attachment or soft brush to clean. Wipe the dehumidifier body with a soft damp cloth or kitchen towel.

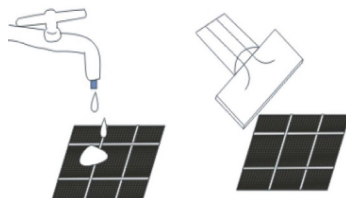

Clean the water tank

Every few weeks, clean the tank to prevent growth of mould, mildew and bacteria. Partially fill the tank with clean water and add a little mild detergent. Swish it around and then empty the tank and rinse. NOTE: Do not use a dishwasher to clean the tank. After cleaning and drying the tank must be reinserted securely into dehumidifier in order to restart operation.

End of Season Maintenance:

1. Empty and clean the water tank.
2. Clean the unit and the filters as per cleaning procedure above.
3. Coil the power cord on the special cord storage rest at the back of the unit
4. Cover the unit and keep it in a dry place.

Power Cord Maintenance and Replacement

If the power cord is damaged, it could cause a short circuit or become a fire risk. Please avoid pulling the cord, twisting or pressing it and keep it away from pets. If the power cord is damaged, power the unit off and unplug it immediately. Contact an electrician or service centre for repairs; do not attempt to repair the unit yourself.

FREQUENTLY ASKED QUESTIONS

Why doesn't the dehumidifier seem to extract much water if the temperature is low?

This is a compressor dehumidifier which works best in temperatures above 15°C. If the temperature is low and the air is dryer than the setting on the humidistat the unit will not extract water. If you want to use a dehumidifier for outside buildings, unheated properties, boats or garages please check our desiccant range.

Why doesn't the unit work /or stops suddenly?

The water tank may be full or displaced. To rectify: empty the tank and carefully place the tank back in the unit. Also the unit may be running in dehumidifying mode with a low room temperature. Please check if the room temperature is lower than 5°C. If so, the unit will stop working while in dehumidifying mode. (unit may be defrosting).

The ambient operating range is between 5°C and 35°C with a relative humidity ranging from 30% to 80%. For maximum efficiency use the unit between 15°C and 32°C.

Sometimes cold and/or hot air comes out from the air outlet grill, why?

When the unit is in dehumidifying mode it absorbs humid air from room and freezes it to reduce the humidity.

During the cold cycle there should be cold air coming out of the unit

During the hot cycle hot dry air should be coming out of the outlet grill.

TROUBLESHOOTING:

Issue	Cause	Solution
Hot or cold air being produced	Normal Operation	When the unit is in dehumidifying mode it absorbs humid air from room and freezes it to reduce the humidity. During the cold cycle there should be cold air coming out of the unit. During the defrost cycle hot dry air should be coming out of the outlet grill.
Unit does not operate	Is the plug properly inserted in the socket?	Insert the plug into the socket and turn the switch on.
	Is the tank full indicator is red?	The water tank is full, float displaced or the tank is not properly inserted. Empty the tank, check the float and make sure the tank is properly inserted in unit.
Front louvres do not open	Louvre motor is blocked	Check if anything is blocking the louvre Try to move gently the louvres up and down while the unit is off If the above fails return the unit to service centre
Dehumidifier does not extract water	Is the unit set to a humidity level lower than the one in the room?	Set the humidity level on the humidistat below current humidity reading.
	Is the temperature too low for water extraction to be efficient?	Increase temperature in the room or reposition the unit.
	Is any intake grill or discharge blocked? Is the unit too close to walls.	Remove obstructions and restart the unit. Ensure a distance of at least 20 cm between the unit & walls
Airflow seems weak	Is filter dirty or clogged?	Please service the filters regularly as per user manual.
Unit is noisy during operation	Is the unit on uneven surface?	Please place on flat horizontal surface. A carpeted surface under the unit will also help reduce the noise caused by vibrations from the compressor
	Is filter clogged?	Please service the filters regularly as per user manual.
E3 or E4	Humidity sensor error	Ensure filters are clean, and use the unit within the prescribed humidity range. Unplug the unit, rest and plug it back in. If error repeats, call for service centre.
E1 or E2	Temperature sensor error	Ensure filters are clean, and use the unit within the prescribed temperature range. Unplug the unit, rest and plug it back in. If error repeats, call for service centre.
E5 or E6	Abnormal Coil sensor temperature or current	Ensure filters are clean, and use the unit within the prescribed humidity and temperature range. Unplug the unit, rest and plug it back in. If error repeats, call for service centre.
Defrost light on	Unit is defrosting	Allow the unit to automatically defrost. The protection will clear after the unit defrosts. Increase temperature in the room if this repeats too often.
Tank full red light	Water tank full notification	Tank is full or is not in the right position-- Empty the tank and replace in the right position.
Any other malfunctions will need to be reported to ElectrIQ service centre. Do not attempt unauthorised repairs as these may invalidate the warranty.		

TECHNICAL DATA

Model	CD20PRO-LE	CD20PRO-LE
Voltage	1Ph, 220-240V~ 50Hz	1Ph, 220-240V~ 50Hz
Dehumidifying capacity	12 L / day (at 30°C / 80%RH)	20 L / day (at 30°C / 80%RH)
Fan Speeds	2	2
Power Consumption	180W	240W
Running Amps	0.91 Amps	1.2 Amps
Tank Capacity	4 litres	4 litres
Humidity settings range	35%~80%	35%~80%
IP RATING	IPX1	IPX1
Refrigeran	R134a, 115 grams	R134a, 160 grams
Airflow m ³ /h	180	180
High / Low Pressure	1.5/0.5MPa	1.5/0.5MPa
Max noise level dB(A)	42-49	42-49
Filters	carbon (optional)	carbon (optional)
Dimensions mm (WxDxH)	380x580x195	380x580x195
Weight kgs	14	14.3
GWP	1430	1430
All information provided is for reference only. Products specifications may change due to continuous product development.		



Disposal: Do not dispose this product as unsorted waste. Collection of such waste must be handled separately as special treatment is necessary.

Recycling facilities are now available for all customers at which you can deposit your old electrical products. Customers will be able to take any old electrical equipment to participating sites run by their local councils. Please remember that this equipment will be further handled during the recycling process, so please be considerate when depositing your equipment. Please contact the local council for details of your local household waste recycling centres.

ElectrIQ UK SUPPORT

www.ElectrIQ.co.uk/support

Please, for your own convenience, make these simple checks before calling the service line.

1. Has the unit been standing upright for at least 2 hours?
2. Is the unit plugged into the mains?
3. Is the fuse OK?
4. Switch the unit off and wait three minutes to see if the issue is resolved. Restart the unit.
5. Check if the water tank is full.
6. Was the troubleshooting guide followed?

If the unit still fails to operate call: 0871 620 1057 or complete the online form

Office hours: 9AM - 5PM Monday to Friday

www.ElectrIQ.co.uk

Unit J6, Lowfields Business Park

Lowfields Way, Elland

West Yorkshire, HX5 9DA

